

MODEL:RA-DB9733

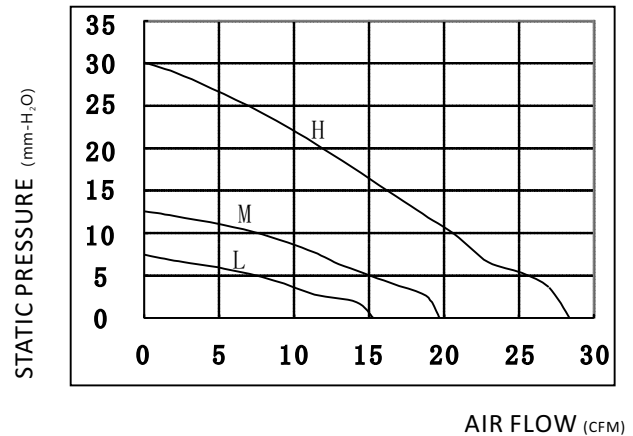

AIR FLOW (CFM)

SPECIFICATION

(L: Low -speed; M: Middle - speed; H: High -speed; U: Ultra high-speed; D: Ultra low-speed)

Voltage (VDC)	Model	Current	Power	Speed	Max air-flow		Max Pstatic	Noise
		A	W	RPM	CMH	CFM	mm-H ₂ O	DbA
12	L	0.17	2.04	2200	25.99	15.30	7.40	39
	M	0.32	3.84	3000	33.47	19.70	12.50	47
	H	0.80	9.60	4000	48.25	28.40	30.10	54
24	L	0.09	2.16	2200	25.99	15.30	7.40	39
	M	0.16	3.84	3000	33.47	19.70	12.50	47
	H	0.40	9.60	4000	48.25	28.40	30.10	54

DRAWING

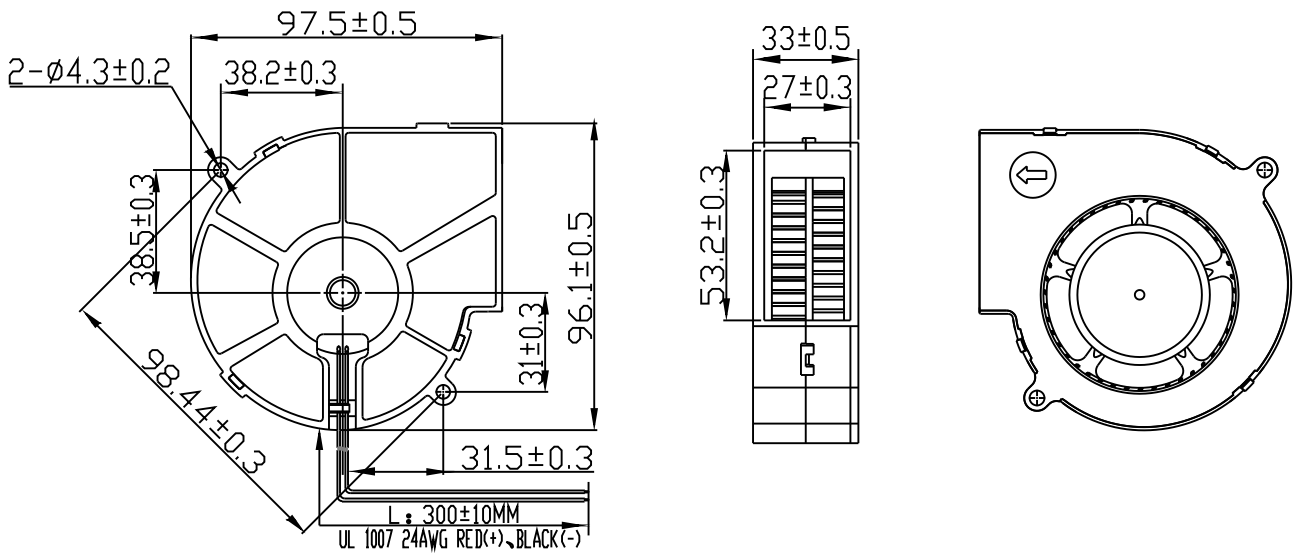

GENERAL DESCRIPTION

1. BEARING TYPE: BALL BEARING OR SLEEVE
2. IMPELLER AND SHELL MATERIAL: PBT / PC
3. MOTOR TYPE: BLDC
4. INSULATION GRADE: E
5. INSULATION RESISTANCE: 10M/500VDC
6. DIELECTRIC STRENGTH: 2MINIMUM/500AVC-5mA
7. AMBIENT HUMIDITY: RH20%-RH75%
8. STORAGE TEMPERATURE: -20°C ~ +75°C
9. WORKING TEMPERATURE: -10°C ~ +70°
10. SERVICE LIFE: 50000 HRS

CUSTOMIZATION FUCTIONS

SPEED CONTROL

- PWM; Vsp; SOFT-START; CLOSED-LOOP; GAPCYCLE RUNNING

OUT SIGNAL

- FG; RD (EXCEED THE MIN. SPEED SETTINGS)

PROTECTION

- LOCKED; WATER-PROOF; DUSTY-PROOF