

### MODEL:RA-DB8530

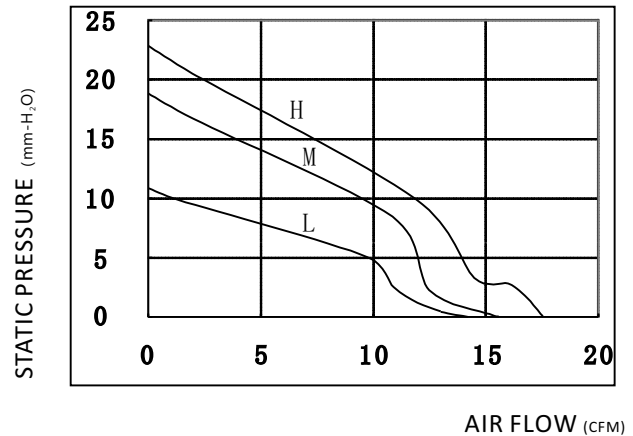

### SPECIFICATION

(L: Low -speed; M: Middle - speed; H: High -speed; U: Ultra high-speed; D: Ultra low-speed)

Voltage (VDC)	Model	Current	Power	Speed	Max air-flow		Max Pstatic	Noise
		A	W	RPM	CMH	CFM	mm-H <sub>2</sub> O	DbA
12	L	0.28	3.36	2800	24.13	14.20	10.88	42
	M	0.44	5.28	3500	26.50	15.60	18.80	48
	H	0.60	7.20	4000	29.90	17.60	22.86	51
24	L	0.18	4.32	2800	24.13	14.20	10.88	42
	M	0.22	5.28	3500	26.50	15.60	18.80	48
	H	0.33	7.92	4000	29.90	17.60	22.86	51

### DRAWING

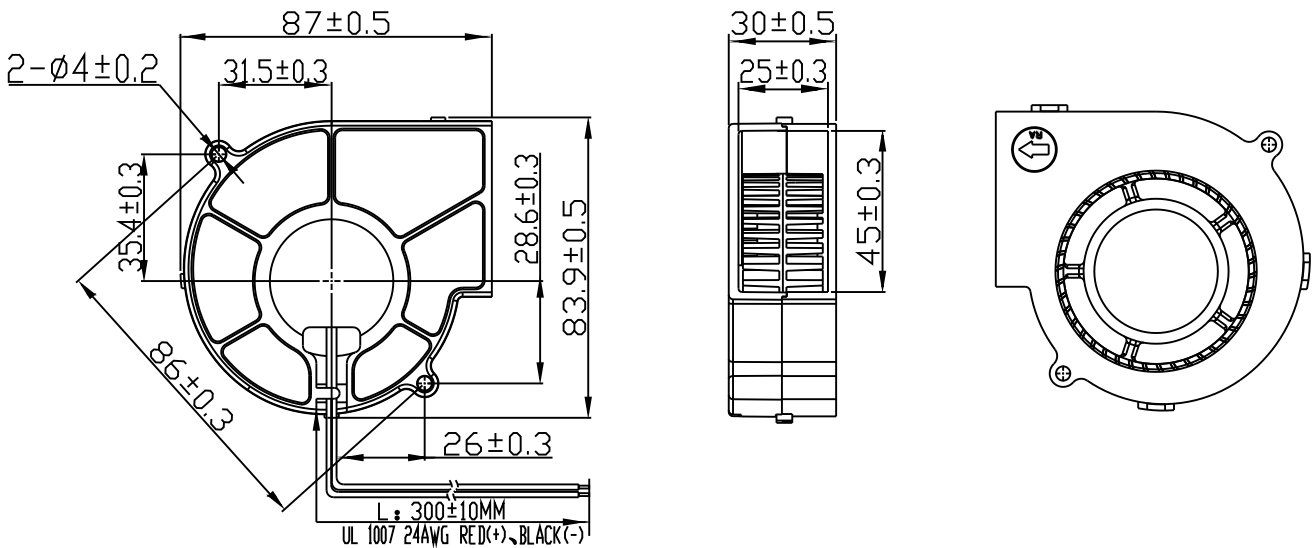

### GENERAL DESCRIPTION

1. BEARING TYPE: BALL BEARING OR SLEEVE
2. IMPELLER AND SHELL MATERIAL: PBT / PC
3. MOTOR TYPE: BLDC
4. INSULATION GRADE: E
5. INSULATION RESISTANCE: 10M/500VDC
6. DIELECTRIC STRENGTH: 2MINIMUM/500AVC-5mA
7. AMBIENT HUMIDITY: RH20%-RH75%
8. STORAGE TEMPERATURE: -20°C ~ +75°C
9. WORKING TEMPERATURE: -10°C ~ +70°
10. SERVICE LIFE: 50000 HRS

### CUSTOMIZATION FUCTIONS

#### SPEED CONTROL

- PWM; Vsp; SOFT-START; CLOSED-LOOP; GAPCYCLE RUNNING

#### OUT SIGNAL

- FG; RD (EXCEED THE MIN. SPEED SETTINGS)

#### PROTECTION

- LOCKED; WATER-PROOF; DUSTY-PROOF