

MODEL:RA-DC9225

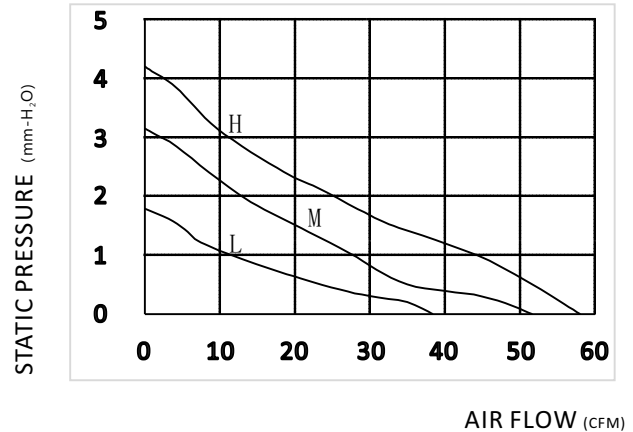

SPECIFICATION

(L: Low -speed; M: Middle - speed; H: High -speed; U: Ultra high-speed; D: Ultra low-speed)

Voltage (VDC)	Model	Current	Power	Speed	Max air-flow		Max Pstatic	Noise
		A	W	RPM	CMH	CFM	mm-H ₂ O	DbA
12	L	0.09	1.08	2000	65.24	38.40	1.78	27
	M	0.14	1.68	2500	87.67	51.60	3.15	32
	H	0.24	2.88	3000	98.54	58.00	4.20	37
24	L	0.07	1.68	2000	65.24	38.40	1.78	27
	M	0.10	2.40	2500	87.67	51.60	3.15	32
	H	0.18	4.32	3000	98.54	58.00	4.20	37

DRAWING

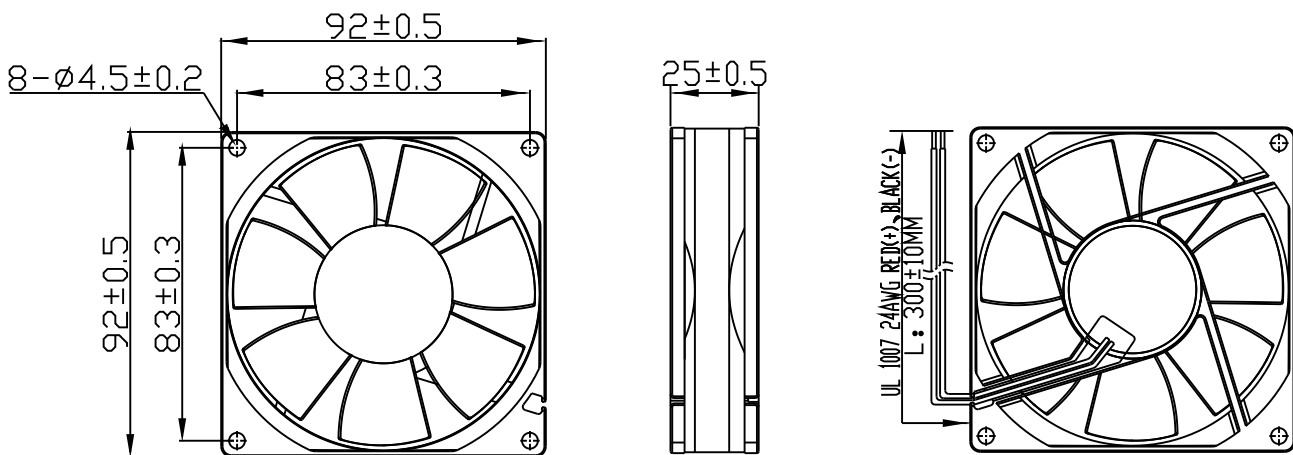

GENERAL DESCRIPTION

1. BEARING TYPE: BALL BEARING OR SLEEVE
2. IMPELLER AND FRAM MATERIAL: PBT
3. MOTOR TYPE: BLDC
4. INSULATION GRADE: E
5. INSULATION RESISTANCE: 10M/500VDC
6. DIELECTRIC STRENGTH: 2MINIMUM/500AVC-5mA
7. AMBIENT HUMIDITY: RH20%-RH75%
8. STORAGE TEMPERATURE: -20°C ~ +75°C
9. WORKING TEMPERATURE: -10°C ~ +70°
10. SERVICE LIFE: 50000 HRS

CUSTOMIZATION FUCTIONS

SPEED CONTROL

- PWM; Vsp; SOFT-START; CLOSED-LOOP; GAPCYCLE RUNNING

OUT SIGNAL

- FG; RD (EXCEED THE MIN. SPEED SETTINGS)

PROTECTION

- LOCKED; WATER-PROOF; DUSTY-PROOF